

5 40 101 1210 0

Add-on slide stainless steel PH 145 cm







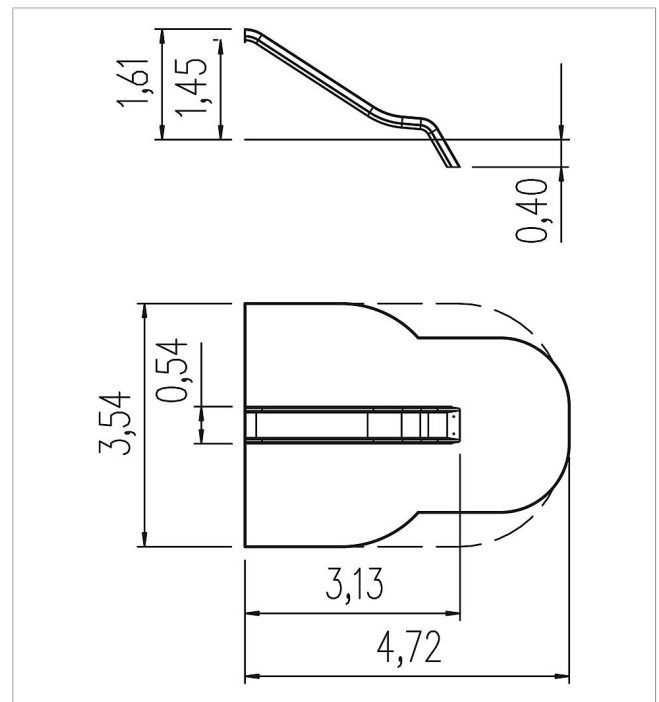

made in germany



Scope of delivery

1 slide PH 145: stainless steel



| | | |
|---|-----------------------|-------------------|
|  | Material | Stainless steel |
|  | Foundation level | FL 1 |
|  | Minimum space | 472x354x325 cm |
|  | Free falling height | 145 cm |
|  | Impact protection net | 14 m ² |
|  | Foundations | 1x CF or 1x PFs |
|  | Assembly | 2 persons/1 h |
|  | Largest section | 375x48x45 cm |
|  | Heaviest section | 100 kg |