

5 25 027 0410 0

unique play unit Tarnuk







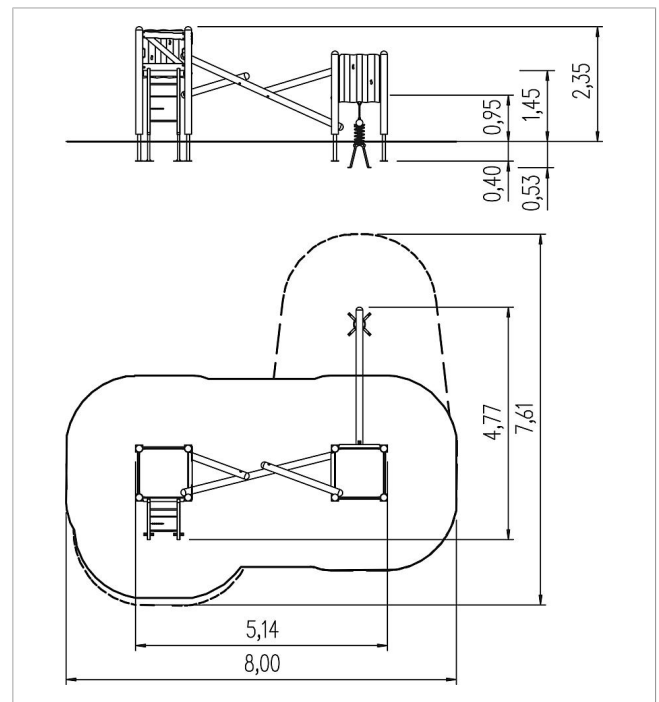

made in germany



Scope of delivery

- 8x post construction: SW or steel
- 2x platform construction: galvanised steel
- 2x platform: HPL
- 1x balance beam with spring: SW, stainless steel, spring steel
- 6x wall panel: SW
- 2x set of grips: steel
- 1x material ladder: SW, stainless steel, polyester-coated steel cable
- 1x zigzag crossover: SW



	Material	Larch GL, Larch
	Foundation level	FL 1
	Minimum space	800x761x335 cm
	Free falling height	145 cm
	Impact protection net	31,5 m ²
	Foundations	11x CF or 10x PFs + 1x CF
	Assembly	-
	Largest section	420xØ 14 cm
	Heaviest section	35 kg